

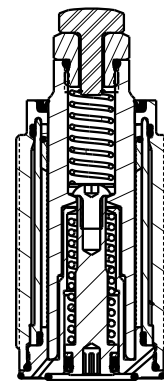

SEE IS1023 FOR SERVICE INSTRUCTIONS.
LUBRICATE ALL SEALS WITH CLEAN HYDRAULIC OIL
PRIOR TO ASSEMBLY.
DO NOT USE SILICONE BASED LUBRICANTS.



APPLY MEDIUM STRENGTH
THREAD LOCKER (BLUE)
TORQUE TO 16 FT-LB

CONTACT BOLT PPS
91060100- Order for
complete assembly

TORQUE TO
40 IN-LB

PLUNGER
These work supports are fully
rebuildable to full factory original
capacity by any authorized Vektek repair
facility. All seals can be replaced by
any authorized repair facility.

BODY ASSEMBLY
- NOT REPLACEABLE
TORQUE TO 100 FT-LB

ASSEMBLE LIP
SIDE TOWARD
BOTTOM OF PISTON

NO	QTY	PART NO	DESCRIPTION	STD SEAL KIT	SPRING KIT
1	1	21410130	BHCS, 1/4-20 x 3/8, SELFLOCK, SST		
2	1	21430011	WASHER		
3	1	23010006	RETAINING RING, C, EXT		
4	1	23350143	SPRING, COMPRESSION		X
5	1	23350144	SPRING, COMPRESSION		X
6	1	39010038	SEAL, BEVEL, 7/16 x 3/32 x 5/8	X	
7	1	39010072	BU RING, (-111)	X	
8	1	39051175	O-RING, (-021)	X	
9	1	39051176	O-RING, 12mm X 2.0mm		
10	1	39051177	O-RING, 40mm X 1.5mm	X	
11	1	81011002	PISTON, WS, FA, HC, 8000		
12	1	81061001	BOLT, ADAPTER, WS, 8000, PPS		
13	1	81061002	BOLT, CONTACT, WS, 8000, PPS		
14	1	39V53005	WIPER, PRESS-IN, (1), VBGV	X	
N/A	N/A	60100145	KIT, SEAL, WS, FA, CM, HC, 8000, PPS	NOTED	N/A
N/A	N/A	61100227	KIT, SPRING, WS, FA, HC, 8000	N/A	NOTED
N/A	N/A	IS1023	INSTRUCTION SHEET	N/A	N/A
N/A	N/A	IS5003	INSTRUCTION SHEET, PPS	N/A	N/A

WEIGHT 1.99 LBS

PARTS LIST



VEKTEK, INC.
1334 E. SIXTH AVE. P.O. BOX 625
EMPORIA, KS. 66801 U.S.A.

ASSEMBLIES AFFECTED
10071010PS

PARTS LIST, ASSY, WS, FA, CM, HC, 8000, PPS

SIZE
A PL1104

REV
B

FORM FEG035_PL_ASIZE, REV. B

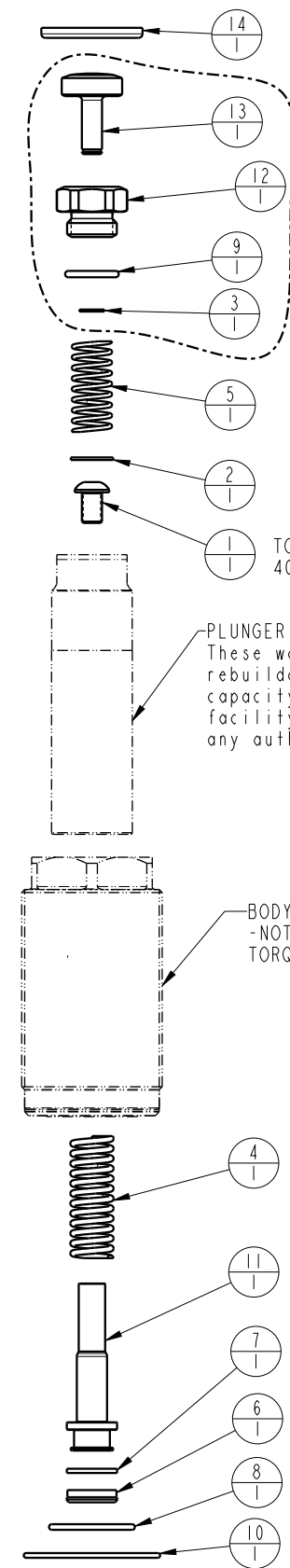

B	5730	RELEASE	JDW	05/31/25
REV	IN ACCORDANCE WITH ECN	EFFECTIVE DATE	REVISED BY	DATE
DRW BY:	ALS	DRAWING STATUS: Released		
DATE:	3/9/20	PRODUCTION APPROVED FOR RELEASED STATUS ONLY		

SHEET 1 OF 1

Vekttek LLC 1334 East Sixth Ave. P.O. Box 625 Emporia, Ks. 66801 U.S.A.	Instruction Sheet	IS	1023	
		REV:	D, I.A.W ECN4133	
		REV. BY/DATE:	ALS	5/11/20
		APPR/DATE:	TDK	5/11/20
TITLE: Disassembly/Assembly Instructions: Inch and Metric High Capacity Fluid Advance Work Supports				

These work supports are fully rebuildable to full factory original capacity by any authorized Vekttek repair facility. All seals can be replaced by any authorized repair facility.

Read all instructions prior to disassembling!

Refer to the illustration on page three for component part numbers and tool list.

Disassembly

1. Unscrew the cartridge assembly (8) from the base (14) or fixture. **Caution- Use a six-point socket only. Other types of wrenches may damage the work support.**
2. Hold the plunger (5) stationary and unscrew the contact bolt (1). Remove contact o-ring (15) from contact bolt (1).
3. Remove the spring (2) and spacer (9) from inside the plunger (5).
4. Hold the piston (7) stationary and unscrew the cap screw (3).
5. Slide the plunger (5) out of the top of the cartridge assembly (8) and then push the piston (7) and spring (12) out of the retainer (13).
6. Remove the wiper (6) from the cartridge assembly (8).
7. Remove the piston seal (10) and piston seal back-up ring (11) from the piston (7), and the seal (4) from the base (14) or fixture.
8. Clean all parts thoroughly and set aside to dry.

Vekttek LLC 1334 East Sixth Ave. P.O. Box 625 Emporia, Ks. 66801 U.S.A.	Instruction Sheet	IS	1023	
		REV:	D, I.A.W ECN4133	
		REV. BY/DATE:	ALS	5/11/20
		APPR/DATE:	TDK	5/11/20
TITLE: Disassembly/Assembly Instructions: Inch and Metric High Capacity Fluid Advance Work Supports				

Assembly

1. Lubricate all O-rings, gaskets, back-up rings and seals with clean hydraulic fluid (Vekttek 65-0010-01 or equivalent). Apply Loctite primer N® or equivalent to the threads of the contact bolt (1) and the retainer (13) and set aside to dry.
2. First install the back-up ring (11) then the piston seal (10) onto the piston (7) with the sealing lips of the piston seal (10) toward the piston (7) base.
3. Slide the spring (12) onto the piston (7) and insert both parts into the retainer (13).
4. Insert the plunger (5) into the top of the cartridge assembly (8).
5. While holding the piston (7) stationary insert the cap screw (3) into the top of the plunger (5) and thread the cap screw (3) into the piston (7). Tighten to the specification on the parts list.
6. Insert the flat washer (9) and the spring (2) into the top of the plunger (5).
7. Install contact o-ring (15) onto contact bolt (1). Apply one drop of Loctite 243® or equivalent to the threads of the contact bolt (1). While holding the plunger (5) stationary tighten the contact bolt (1) to the plunger (5). Tighten to the torque specification on the parts list.
8. If using o-ring, place the o-ring (4) flat in the bottom of the retainer (13). Insert the work support assembly into the base (14) or mounting cavity and tighten it to the torque specification on the parts list.
Caution- Use a six-point socket only. Other types of wrenches may damage the work support. Note- Use o-ring if cavity abides by ILS100730 or ILMV100723. Use o-ring OR gasket, not both.
9. If using gasket, place the gasket (4) flat in the bottom of the base (14) or mounting cavity. Insert the work support assembly into the base (14) or mounting cavity and tighten it to the torque specification on the parts list.
Caution- Use a six-point socket only. Other types of wrenches may damage the work support.

Vekttek LLC 1334 East Sixth Ave. P.O. Box 625 Emporia, Ks. 66801 U.S.A.	Instruction Sheet	IS 1023	
		REV: D, I.A.W ECN4133	
		REV. BY/DATE: ALS	5/11/20
		APPR/DATE: TDK	5/11/20
TITLE: Disassembly/Assembly Instructions: Inch and Metric High Capacity Fluid Advance Work Supports			

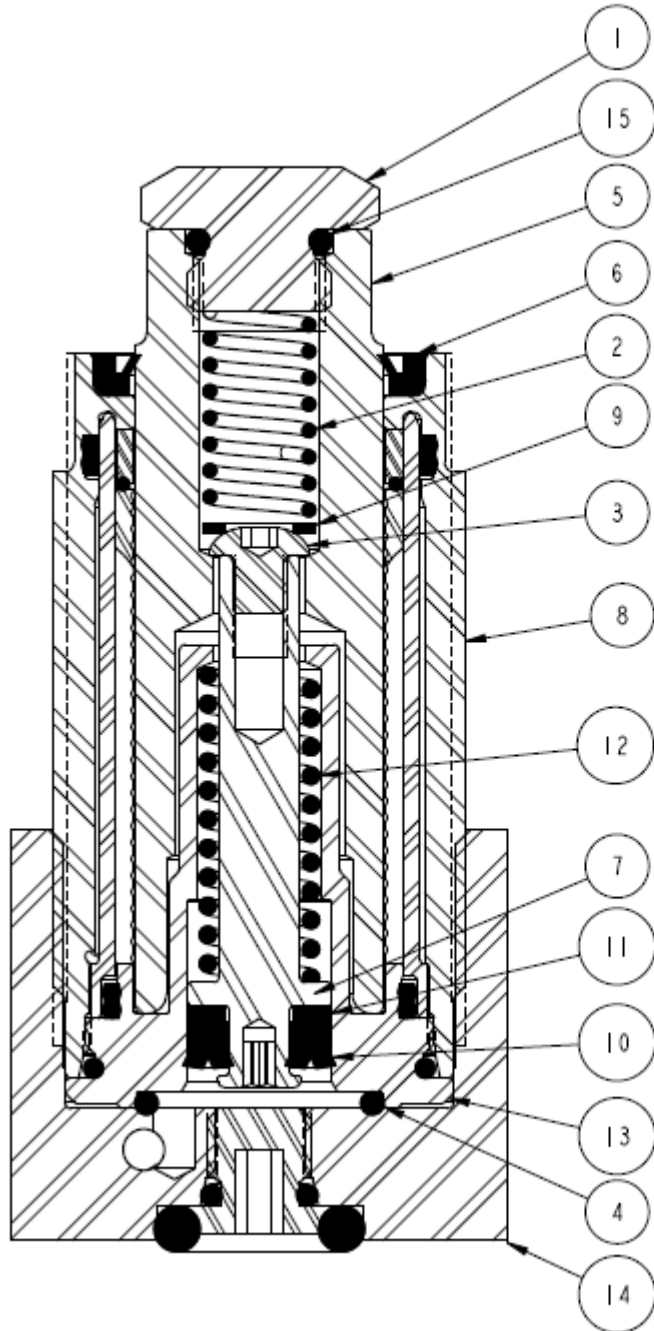

15	CONTACT O-RING
14	BASE
13	RETAINER
12	CONTACT SPRING
11	BACK-UP RING
10	PISTON SEAL
9	FLAT WASHER
8	CARTRIDGE ASSY
7	PISTON
6	WIPER
5	PLUNGER
4	SEAL
3	CAP SCREW
2	CONTACT SPRING
1	CONTACT BOLT
Item	Description

Vektek LLC 1334 East Sixth Ave. P.O. Box 625 Emporia, Ks. 66801 U.S.A.	Instruction Sheet	IS5003			
		REV:	E	ECN:	5587
		REV. BY/DATE:	KR	01/27/25	
		APPR/DATE:	BCD	01/27/25	
TITLE: Pneumatic Confirmation Application Setup Guide					

Air Sensing Control Kit



Pneumatic Confirmation Valves

Block Style



Cartridge Style



Part Present Sensing Work Supports



Vektek LLC 1334 East Sixth Ave. P.O. Box 625 Emporia, Ks. 66801 U.S.A.	Instruction Sheet	IS5003			
		REV:	E	ECN:	5587
		REV. BY/DATE:	KR	01/27/25	
		APPR/DATE:	BCD	01/27/25	
TITLE: Pneumatic Confirmation Application Setup Guide					

Contents

Air Sensing Control Kit Setup.....	4
ASCK Setup	5
Pneumatic Confirmation Valve.....	7
Introduction to the Pneumatic Confirmation Valve.....	8
Applications.....	9
Machine Integration & Part Load/Unload Automation	10
Part Clamped Confirmation:.....	10
Unclamp Confirmation prior to robotic workpiece removal:.....	10
Mounting the Valve.....	11
Bottom mounting:.....	11
Bottom Mounting Pattern:	11
Side mounting:.....	12
Side Mounting Pattern:	12
Designing the Actuator.....	13
Example 1:.....	13
Example 2:.....	14
Adjusting the Actuator	14
Adjustment Steps:.....	15
Recommended Circuit Design	16
Circuit Design Tips:	16
System Tuning Process.....	17
Tuning Steps:	17
Trouble Shooting.....	19
Part Present Sensing Work Supports:	20
Introduction:.....	20
Part Present Sensing Circuit Design:	20
Circuit Components:.....	21

Vektek LLC 1334 East Sixth Ave. P.O. Box 625 Emporia, Ks. 66801 U.S.A.	Instruction Sheet	IS5003			
		REV: E	ECN: 5587		
		REV. BY/DATE: KR	01/27/25		
		APPR/DATE: BCD	01/27/25		
TITLE: Pneumatic Confirmation Application Setup Guide					

Position Sensor Setup:..... 21

System Tuning Information..... 21

System Tuning Steps 24

Trouble Shooting 25

Vektek LLC 1334 East Sixth Ave. P.O. Box 625 Emporia, Ks. 66801 U.S.A.	Instruction Sheet	IS5003			
		REV:	E	ECN:	5587
		REV. BY/DATE:	KR	01/27/25	
		APPR/DATE:	BCD	01/27/25	
TITLE: Pneumatic Confirmation Application Setup Guide					

Air Sensing Control Kit Setup



Air Sensing Kit Model No.	Domestic	Metric	7MPa
	50-8240-00	45-0824-00	L5-0824-00
	Pneumatic		
	P5-0824-00		

The Air Sensing Control Kit (ASCK) is a complete package used to supply, control, and monitor the air pressure and flow of pneumatic confirmation valves, part present sensing work supports, or other orifice devices used to detect the presence of the workpiece on a fixture or clamp position. It consists of a pressure regulator/filter/gauge connected to a flow control with an electronic pressure switch monitoring the downstream air pressure changes in the system. The ASCK unit can be setup and tuned to a variety of system configurations and sizes. The industry standard M12 pressure switch cable connects to the CNC machine control system. The air input is connected to clean, non-lubricated shop air. The air output can be connected directly, through a pallet de-coupler, or through a rotary union to the downstream devices. Tuning the ASCK to the downstream device configuration is quick and easy.

Vektek LLC 1334 East Sixth Ave. P.O. Box 625 Emporia, Ks. 66801 U.S.A.	Instruction Sheet	IS5003			
		REV: E	ECN: 5587		
		REV. BY/DATE: KR	01/27/25		
		APPR/DATE: BCD	01/27/25		
TITLE: Pneumatic Confirmation Application Setup Guide					

ASCK Setup

1. Mount the ASCK in a suitable location using the mounting holes in the rear flange.
2. Connect the electronic pressure switch male M12 electrical connection using the M12 patch cable to the CNC machine control system to monitor system pressure changes. 24 VDC power must be supplied to the electronic pressure switch in addition to connecting the digital signal Pin No. 4 properly for PNP signal. Connection of the digital signal Pin 5 and analog signal Pin 2 is optional. See the table below for proper connections.

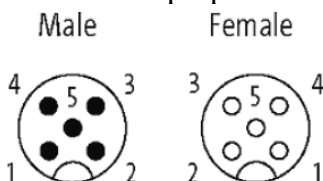

Pin No.	Wire Color	Function
1	Brown	+24V
2	White	Analog Signal
3	Blue	- 0V
4	Black	Set Point 1
5	Green/Yellow	Set Point 2

For NPN signal, the optional PNP-NPN converter cable 27-8420-00 can be ordered separately and used. Connections are the same accept digital Pin 5 for set point 2 which is not available.

3. The electronic pressure switch is pre-programmed as follows for startup of ASCK. Adjust as needed for the particular CNC control system and part sensing configuration. See IS7075 for detailed electronic pressure switch instructions.
 - a. Output 1 set to “Normally Open” (Hno).
 - b. Output 2 set to “Off”.
 - c. Analog Output (OuA) set to “Off”.
 - d. Set Point 1 (SP1) set to 15 psi (100 kPa).
 - e. Reset Point 1 (RP1) set to 10 psi (70 kPa).
4. Connect the ASCK air output to the downstream devices using air hose supplied with the kit or other airline tubing.
5. Connect shop air supply to the ASCK air inlet next to the regulator/filter/gauge.

Vekttek LLC 1334 East Sixth Ave. P.O. Box 625 Emporia, Ks. 66801 U.S.A.	Instruction Sheet	IS5003		
		REV: E	ECN: 5587	
		REV. BY/DATE: KR	01/27/25	
		APPR/DATE: BCD	01/27/25	
TITLE: Pneumatic Confirmation Application Setup Guide				

6. Adjust the air regulator pressure to the required system input pressure between the ranges of 0-25 psi (0-170 kPa). It is recommended that this be set near the maximum allowable pressure for the system or 20-25 psi (140-170 kPa) when the downstream devices are closed.
7. Adjust the flow control to allow air flow to the downstream devices to an acceptable level and to achieve a system pressure of approximately 5 psi (35 kPa) with the devices open.
8. Test the ASCK by opening and closing each downstream device to see if the red LED light for SP1 comes on when the device is closed and Set Point 1 pressure is reached. Closing the device closes the Set Point 1 contacts and a signal is sent to the CNC control system to indicate that the part is present or clamped.
9. Adjust the air regulator, flow control, and electronic pressure switch as needed to achieve the desired result for each system.

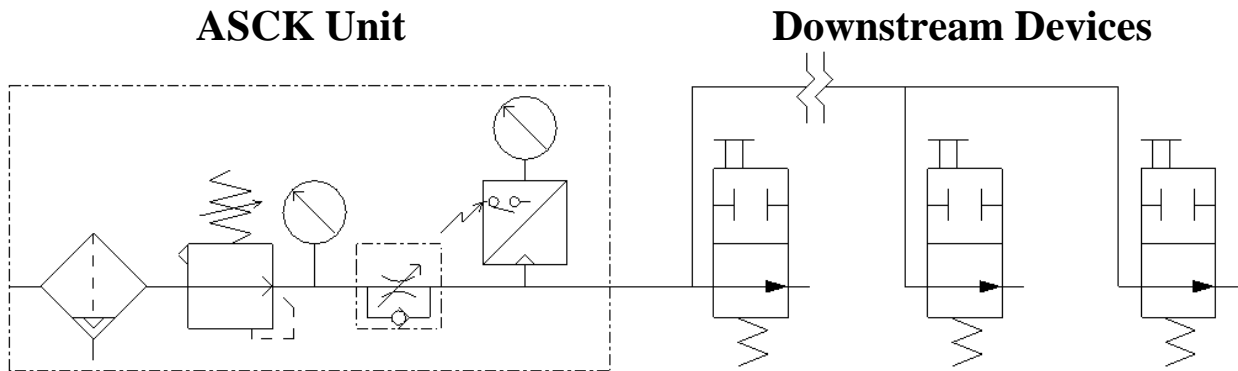

Vektek LLC 1334 East Sixth Ave. P.O. Box 625 Emporia, Ks. 66801 U.S.A.	Instruction Sheet	IS5003			
		REV:	E	ECN:	5587
		REV. BY/DATE:	KR	01/27/25	
		APPR/DATE:	BCD	01/27/25	
TITLE: Pneumatic Confirmation Application Setup Guide					

Pneumatic Confirmation Valve

Block Style:

50-4085-00, 50-4085-01 (Inch)
 45-0485-00, 45-0485-01 (Metric)
 L5-0485-00, L5-0485-01 (7MPa)

Cartridge Mount:

50-4095-00, 50-4095-01 (Inch)
 45-0495-00, 45-0495-01 (Metric)
 L5-0495-00, L5-0495-01 (7MPa)



Vekttek LLC 1334 East Sixth Ave. P.O. Box 625 Emporia, Ks. 66801 U.S.A.	Instruction Sheet	IS5003			
		REV:	E	ECN:	5587
		REV. BY/DATE:	KR	01/27/25	
		APPR/DATE:	BCD	01/27/25	
TITLE: Pneumatic Confirmation Application Setup Guide					

Introduction to the Pneumatic Confirmation Valve

The pneumatic confirmation valve is a normally open valve that provides position confirmation by creating back pressure when the valve plunger is moved to the closed position.

The valve is available in two models: an Over-Travel Sensing and a Standard model in either block style or cartridge mount, see table below. Both valves have .40" plunger stroke. Both are open in the extended position from 0-.080" of stroke. Both valves are closed by .080" travel. See logic charts below.

The over-travel sensing valve re-opens at .325" or the last .075" of travel to allow sensing of a clamp over-travel condition if a workpiece isn't present. The over-travel valve has .245" of usable "closed position" stroke.

The standard valve stays closed to the bottom of the .40" stroke. The standard valve has .32" of usable "closed position" stroke.

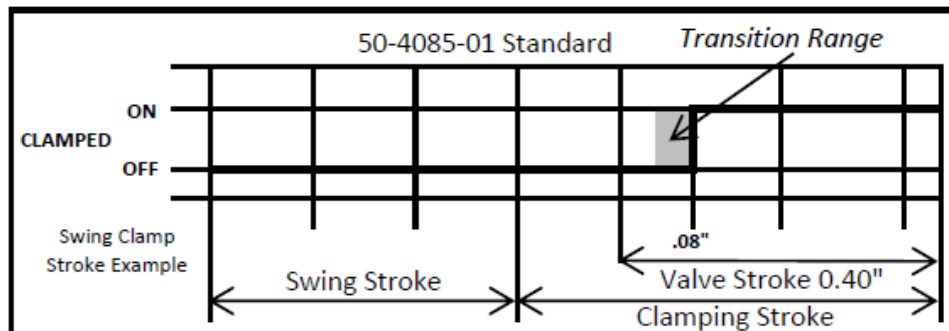
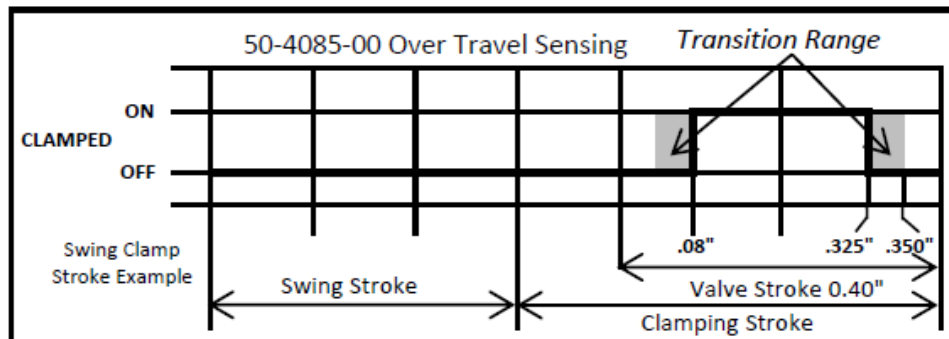

Vektek LLC 1334 East Sixth Ave. P.O. Box 625 Emporia, Ks. 66801 U.S.A.	Instruction Sheet	IS5003			
		REV:	E	ECN:	5587
		REV. BY/DATE:	KR	01/27/25	
		APPR/DATE:	BCD	01/27/25	
TITLE: Pneumatic Confirmation Application Setup Guide					

Applications

The pneumatic confirmation valve is an accessory valve that can be used in many applications and with almost any clamping device. It is used to avoid machine crashes or to help detect missing or misloaded parts. Most commonly it is used to confirm the position of a clamp arm or lever. It can be positioned in the clamped position to provide feedback to machine control logic confirming that the clamp is in position and therefore the work piece clamped. It can also be used in robotic applications to provide feedback to machine control logic that the clamp is fully unclamped so the clamp arm is out of the way and the robot is safe to remove a completed work piece.

The pneumatic confirmation valve could also be used for part presence sensing. It can be located so that the work piece actuates the plunger into the closed position. It is **not** to be used as a workpiece locator. Using it as a hard datum will damage the valve and void product warrantee.

The pictures on the next page show applications where “clamped position” confirmation was desired.



The benefit of using an accessory valve of this type and an actuator mounted to the clamp arm is that if the clamp arm is moved by an operator or gets destroyed by a cutter from close quarter machine tool paths, so will the actuator. Therefore, no clamp confirmation signal will be provided because the pneumatic confirmation valve plunger was not actuated and no pressure reading at the sensor switch. When the plunger is actuated, it guarantees that the work piece is being clamped because the clamp arm and actuator have to be in the correct position.

Other companies offer position sensing integrated into their clamping devices but their downside is they can provide false feedback. If the clamping arm gets moved or damaged, the internal sensor cannot distinguish and will provide false feedback only based on clamp piston actuation. The most fool proof position sensing is to confirm clamp arm position using an actuator mounted to the clamp arm itself.

The pneumatic confirmation valve is a “fail safe” feedback device. It operates on the principle of pressure rise before providing confirmation. It requires all elements in the circuit to close before back pressure can build. If a single valve doesn’t close, it will not make pressure and therefore alert that one clamp is not in the desired position. This requires the system be properly tuned. For example, if a line gets cut, the valve will not build pressure and cannot show a false positive.

Vektek LLC 1334 East Sixth Ave. P.O. Box 625 Emporia, Ks. 66801 U.S.A.	Instruction Sheet	IS5003			
		REV: E	ECN: 5587		
		REV. BY/DATE: KR		01/27/25	
		APPR/DATE: BCD		01/27/25	
TITLE: Pneumatic Confirmation Application Setup Guide					

Machine Integration & Part Load/Unload Automation

The pneumatic confirmation valve is a key element when using machine automation to load/unload parts. Many problems that exist on the shop floor can be monitored by using pneumatic confirmation to know the exact position of the clamp arm. Two common problems will be discussed below: is my part clamped, or have my clamps moved so that I can robotically remove the work piece.

Part Clamped Confirmation:

Many production machining plants today desire feedback that the work piece has been correctly loaded and clamped before the machining operation begins. Doing so can save hundreds of thousands of dollars per year in scrap and reduce down time due to broken tools, damaged spindles etc. If this is your requirement, the pneumatic confirmation valve with the over-travel sensing option is the valve to use. To confirm that the part is correctly loaded and clamped, simply install a valve next to each clamp whose position is to be monitored. Then create machine automation logic to ask for the pneumatic pressure switch confirmation before cycle start. The logic could go something like this:

- 1) Load work piece and actuate valve to pressurize the clamp circuit
- 2) Once your hydraulic system has reached operating pressure, ask for state of the pneumatic pressure switch monitoring the pneumatic confirmation valve circuit.
- 3) If all the clamp arms are in position, the valves will be closed and the pressure at the switch will have met the set point requirement. The switch will provide the feedback logic a positive signal to proceed to the next step, cycle start etc.
- 4) If any one of the confirmation valves has not been actuated by the clamp arm then it will be open and pressure will not build in the pneumatic circuit or at the pressure switch. The set point will not be reached and the switch will provide a negative signal indicating a problem and to stop the process.
- 5) If a work piece was not loaded, the clamps will over-travel which internally re-opens the valve so it will not build pressure. The pressure switch will provide negative feedback to the machine automation logic indicating a problem.

Unclamp Confirmation prior to robotic workpiece removal:

In robotic applications, it is important to know that all the clamps are out of the way so that the work piece can be removed without crashing the robot and causing damage to the robot or end effector. Use the pneumatic confirmation valve standard model to sense the unclamped position of the clamp arm. Install the valve so that the plunger is actuated by the clamp arm or some accessory actuator in the unclamped position. Then create machine automation logic to ask for the pneumatic pressure switch confirmation before cycle start. The logic could go something like this:

- 1) Shift valve to pressurize unclamp circuit and move clamps to unclamped position.
- 2) Once the hydraulic system has reached operating pressure in the unclamp circuit, ask for the state of the pneumatic pressure switch monitoring the pneumatic confirmation valve circuit.

Vektek LLC 1334 East Sixth Ave. P.O. Box 625 Emporia, Ks. 66801 U.S.A.	Instruction Sheet	IS5003			
		REV: E	ECN: 5587		
		REV. BY/DATE: KR	01/27/25		
		APPR/DATE: BCD	01/27/25		
TITLE: Pneumatic Confirmation Application Setup Guide					

- 3) If all clamps have reached the unclamped position, all the pneumatic confirmation valves will be closed and pressure at the pneumatic switch will have met the set point. The switch will signal the feedback logic a positive signal indicating all is clear and ready for robot to remove the work piece.
- 4) If any or one clamp has not reached the unclamp position, the pneumatic confirmation valve plunger will not have been actuated and will be open so that the pneumatic circuit cannot build pressure. Pressure at the switch will not have met the set point and the switch will send a negative signal to the feedback logic indicating a potential crash and to stop the robot from removing the work piece.

Mounting the Valve

The pneumatic confirmation valve has two mounting options; bottom and side mounting for block style and cartridge mount. Locate the valve next to your clamp and design an actuator arm to contact the pneumatic confirmation valve piston.

Bottom mounting:

Bottom mounting is the most popular because the manifold mount ports can be used to feed air into and out of the valve, see blue arrows below indicating air flow.

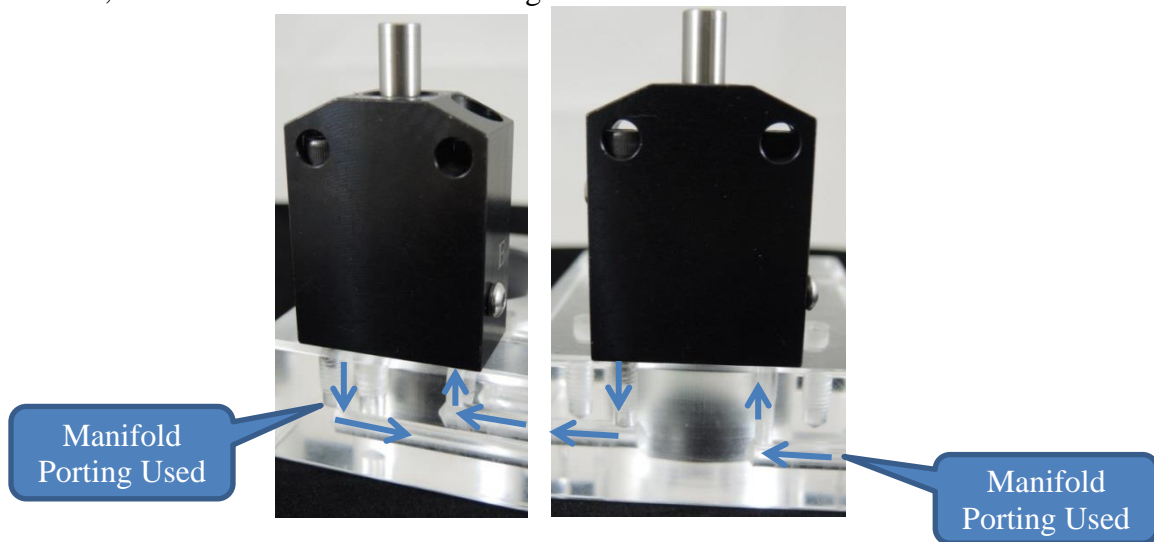

Bottom Mounting Pattern:

Follow the drawing on the next page to create mounting screws pattern and manifold feed holes. The valve mounts into place using 2X 8-32 X 1-3/8" SHCS or 2X M4-0.7 X 35mm SHCS. Air feeds into the valve through the "E" Input port. Air flows out of the valve through the "A" Output port which must be vented to atmosphere.

Vekttek LLC 1334 East Sixth Ave. P.O. Box 625 Emporia, Ks. 66801 U.S.A.	Instruction Sheet	IS5003		
		REV: E	ECN: 5587	
		REV. BY/DATE: KR	01/27/25	
		APPR/DATE: BCD	01/27/25	
TITLE: Pneumatic Confirmation Application Setup Guide				

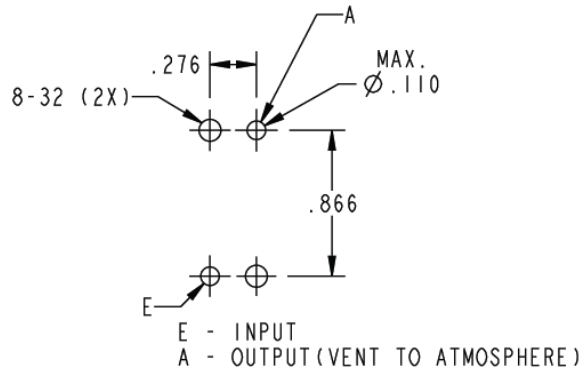

Side mounting:

Side mounting is also available for those applications where it is more convenient. Air will have to be fed through the M3 ports on the side or bottom using external plumbing. The plugs from the side ports must be moved to plug the bottom manifold mounting ports.



Plugs
 installed in
 Manifold

Side Mounting Pattern:

Use the drawing on the next page to create the mounting screw pattern for side mounting. Use 2X 10-24 X 1" SHCS for side mounting. Air feeds into the valve through the E Port. Air flows out of the valve through the A Port which must be vented to atmosphere.

Vekttek LLC 1334 East Sixth Ave. P.O. Box 625 Emporia, Ks. 66801 U.S.A.	Instruction Sheet	IS5003			
		REV: E	ECN: 5587		
		REV. BY/DATE: KR		01/27/25	
		APPR/DATE: BCD		01/27/25	
TITLE: Pneumatic Confirmation Application Setup Guide					

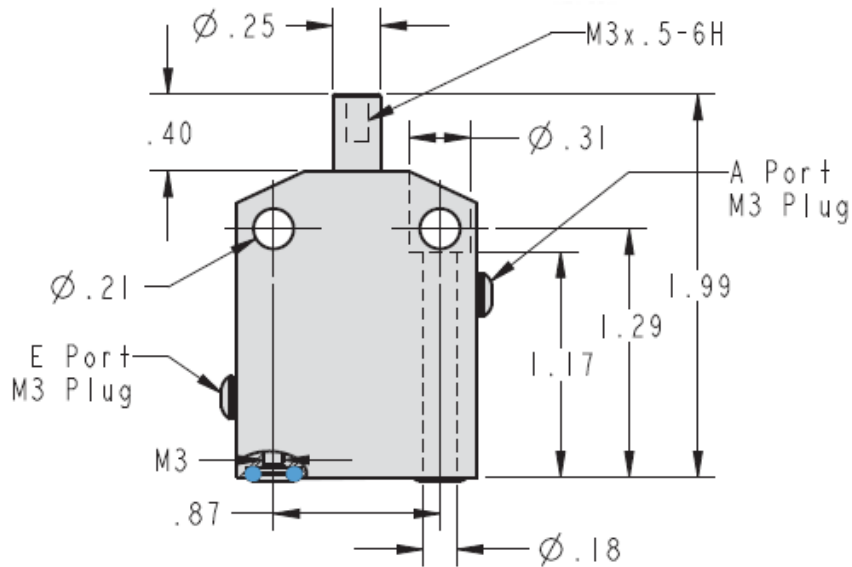

Designing the Actuator

An actuator attached to the clamp arm is required to use the pneumatic confirmation valve. It is not included with the valve. The actuator should contact the plunger on centerline and be adjustable so that the valve plunger travel can be tuned. Improper adjustment could cause damage to the pneumatic confirmation valve or the actuator arm bracket if the clamp over travels. See “Adjusting the Actuator” for details on how to properly adjust.

There are many actuator designs. Two have been shown on the next page for examples. Actuator designs can be as simple or elegant depending on requirements per the application. The actuator can be a bolt, tab or even the clamp arm its self as long as adjustment is built in.

Example 1:

Angle bracket attached to swing clamp arm and a socket head cap screw used as an actuator. The bolt & jam nuts used for adjustment.

When using a swing clamp, ensure the actuator does not contact the valve plunger while swinging. This will damage the valve. Make sure the actuator contacts the plunger once the swing clamp is traveling in the straight portion of the clamping stroke.

Vektek LLC 1334 East Sixth Ave. P.O. Box 625 Emporia, Ks. 66801 U.S.A.	Instruction Sheet	IS5003		
		REV: E	ECN: 5587	
		REV. BY/DATE: KR	01/27/25	
		APPR/DATE: BCD	01/27/25	
TITLE: Pneumatic Confirmation Application Setup Guide				

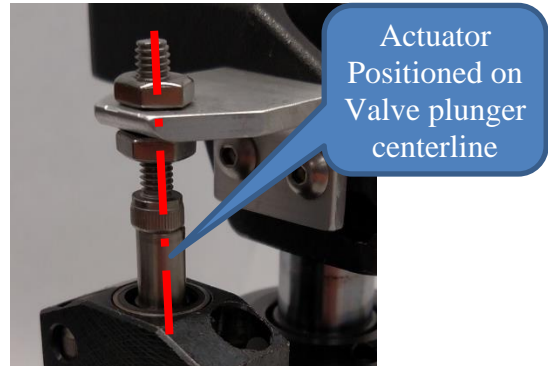
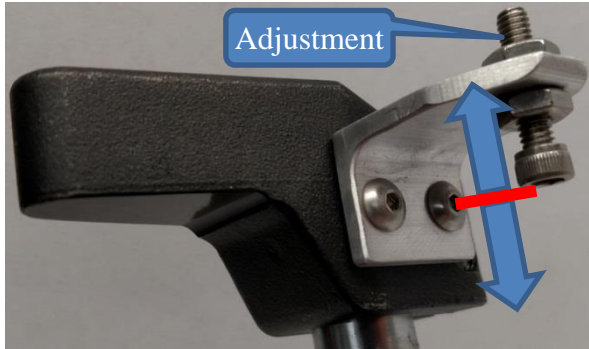

Example 2:

The link clamp lever is used as the actuator. The adjustment comes from threading an M3 button head cap screw into the valve plunger and locking it with a jam nut. Remove the bottom cap & spring to access the 3mm hex on the bottom end of the plunger for torquing attachment to top thread of plunger. Torque cap to 25in-lb.

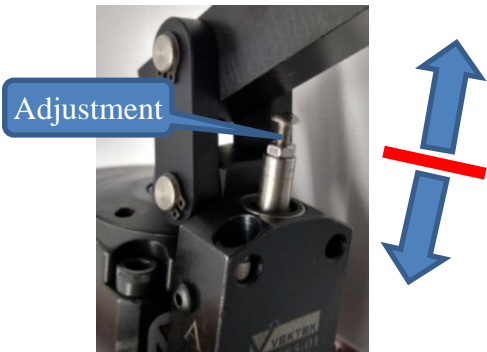

Adjusting the Actuator

Properly adjusting the actuator is one of the most important steps in setting up the pneumatic confirmation valve. If the actuator is adjusted to long, it will crush the pneumatic confirmation valve or damage the actuator when the clamp travels to the bottom of its stroke with no part present. It is very important to adjust the actuator so that when the clamp moves to the end of the clamping stroke there is clearance between the actuator and the top of the pneumatic confirmation valve body. Vektek recommends .025+/- .020" clearance, see drawing on the next page.

Vekttek LLC 1334 East Sixth Ave. P.O. Box 625 Emporia, Ks. 66801 U.S.A.	Instruction Sheet	IS5003			
		REV:	E	ECN:	5587
		REV. BY/DATE:	KR	01/27/25	
		APPR/DATE:	BCD	01/27/25	
TITLE: Pneumatic Confirmation Application Setup Guide					

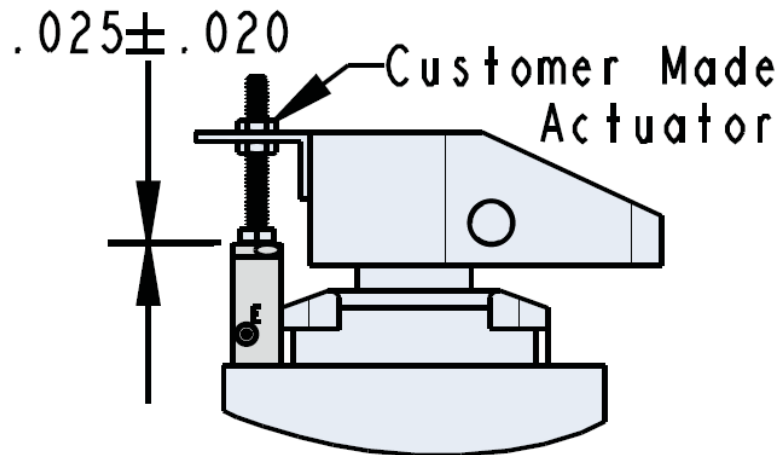

Adjustment Steps:

- 1) With clamp in unclamped position, install actuator.
- 2) Adjust actuator so that there is ample clearance between top of valve body and contact end of actuator.
- 3) Cycle clamp to bottom of clamping stroke position. (not clamping over a work piece)
- 4) Adjust actuator to have .025+/- .020" clearance over top of valve body.
- 5) Cycle clamp to unclamped position and load work piece into fixture.
- 6) Cycle clamp to clamped position and adjust contact bolt on arm so that valve plunger is in the center of the closed stroke.
- 7) Cycle clamp several times to confirm.

Vekttek LLC 1334 East Sixth Ave. P.O. Box 625 Emporia, Ks. 66801 U.S.A.	Instruction Sheet	IS5003			
		REV: E	ECN: 5587		
		REV. BY/DATE: KR		01/27/25	
		APPR/DATE: BCD		01/27/25	
TITLE: Pneumatic Confirmation Application Setup Guide					

Recommended Circuit Design

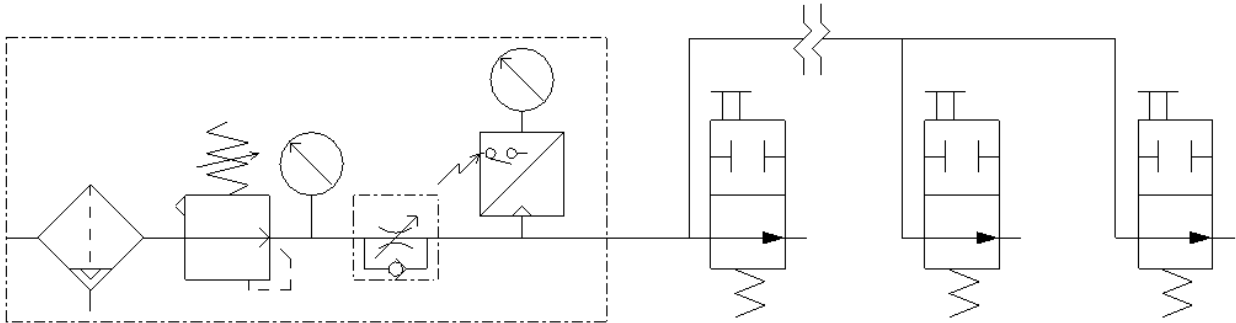

Vekttek recommends the Air Sensing Control Kit for use with the Pneumatic Confirmation Valve. *Air supply pressure and flow should be great enough that system is not starved for air pressure and flow.*

Air Sensing Control Kits:

Domestic product: 50-8240-00

Metric product: 45-0824-00

7MPa product: L5-0824-00

Pneumatic product: P5-0824-00

Circuit Design Tips:

- 1) If using multiple valves, plumb in parallel, as shown above.
- 2) Vent "A Output" port to atmosphere. Remote venting recommended in coolant applications. Make sure coolant or chips cannot block output port.
- 3) Design circuit as simple as possible to be free from flow restrictions that can cause excessive pressure drop.
- 4) Maximum recommended number of valves in one circuit is 8. More than 8 valves may result in poor system performance due to internal leakage rates and or circuit pressure drop.

Vektek LLC 1334 East Sixth Ave. P.O. Box 625 Emporia, Ks. 66801 U.S.A.	Instruction Sheet	IS5003			
		REV: E	ECN: 5587		
		REV. BY/DATE: KR	01/27/25		
		APPR/DATE: BCD	01/27/25		
TITLE: Pneumatic Confirmation Application Setup Guide					

System Tuning Process

Tuning the system is the last step in successfully using the pneumatic confirmation valve. Before the system can be tuned, the following parameters must be chosen.

Valve “Closed” Pressure: _____ PSI
 Sensor “Set Point” Pressure: _____ PSI
 Sensor “Reset” Pressure: _____ PSI
 Valve “Open” Pressure: _____ PSI

The Valve “Closed” Pressure is the back pressure that builds when all the valves in the circuit close. This parameter needs to be higher than all other pressures. This pressure is tuned by adjusting the pressure regulator. Vektek recommends 25 PSI (170 kPa).

The Sensor “Set Point” Pressure is the pressure chosen and programmed into the sensor switch that will cause a change of state during pressure rise. This pressure must be lower than the Valve “Closed” Pressure. Vektek recommends about 60% of the valve closed pressure or 15 PSI (100 kPa).

The Sensor “Reset” Pressure is the pressure chosen and programmed into the sensor switch that will cause a change of state during pressure fall. This pressure must be lower than the Sensor “Set Point” Pressure. Vektek recommends about 40% of the valve closed pressure or 10 PSI (70 kPa).

The Valve “Open” Pressure is the low pressure level resulting from the valve at end of the circuit being open, all other valves closed. Vektek recommends about 20% of the valve closed pressure or 5 PSI (35 kPa). This pressure is tuned by adjusting the flow control valve.

Tuning Steps:

- 1) Cycle clamps so that all the valves plungers are in the “closed” position.
- 2) Adjust pressure regulator until the desired Valve “Closed” Pressure is achieved.
- 3) Manually move clamp to open the pneumatic confirmation valve that is located at the further point away from the pressure sensor switch. Then adjust the flow control valve so that Valve “Open” Pressure is achieved.
- 4) Repeat steps 2 & 3 until both pressure are achieved. Adjusting the regulator or flow control can change both the “Closed” & “Open” pressures.

Vektek LLC 1334 East Sixth Ave. P.O. Box 625 Emporia, Ks. 66801 U.S.A.	Instruction Sheet	IS5003		
		REV: E	ECN: 5587	
		REV. BY/DATE: KR	01/27/25	
		APPR/DATE: BCD	01/27/25	
TITLE: Pneumatic Confirmation Application Setup Guide				

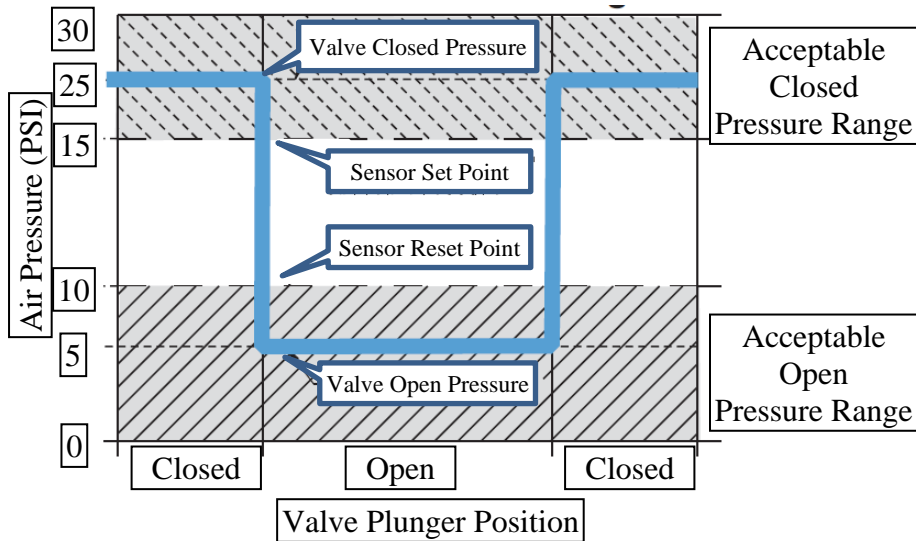

Vektek LLC 1334 East Sixth Ave. P.O. Box 625 Emporia, Ks. 66801 U.S.A.	Instruction Sheet	IS5003			
		REV: E	ECN: 5587		
		REV. BY/DATE: KR	01/27/25		
		APPR/DATE: BCD	01/27/25		
TITLE: Pneumatic Confirmation Application Setup Guide					

Trouble Shooting

Problem	Cause	Corrective Action
My system will not build pressure.	Valve(s) are not being closed.	Adjust actuator, see section adjusting the actuator.
My system will not build pressure, I've confirmed that all valves are being closed.	Pressure and flow are too low.	Increase pressure and flow by adjusting pressure regulator and flow control. See System Tuning Process and repeat the tuning steps.
My system will not drop pressure.	Valves(s) are not being opened.	Adjust actuator, see section adjusting the actuator.
My system will not drop pressure, I've confirmed that all valves are being opened.	Pressure and flow are too high.	Decrease pressure and flow by adjusting pressure regulator and flow control. See System Tuning Process and repeat the tuning steps.
My system pressure will not drop when all the valves are opened.	Possible block in the line somewhere.	Make sure air is venting to atmosphere at all valve output ports.
I'm using the over-travel model valve, it doesn't re-open when my clamp bottoms out when not clamping over a work piece.	Actuator not properly adjusted.	See adjusting the actuator section and follow steps to position actuator .025+/- .020" above the top of the valve body.
I tuned my system with all the valves open. When one valve opens, the pressure doesn't fall below the reset point.	Air flow is too high. Or, improper plumbing of valves (could be connected in series).	See System Tuning Process and repeat the tuning steps using only one valve in the open state to set air flow.
With the line plugged, I set my pressure regulator to 25 PSI, when I connect 8 valves the pressure only builds to 18 PSI in the closed position.	Clearances inside the valve allow a slight air pressure loss in the closed position.	Nothing is wrong with the valve. Repeat tuning steps 1 through 4 to compensate for internal pressure loss. Increasing pressure and flow will compensate for the losses.
I replaced one valve on my fixture. When the valves close, the set point is no longer reached.	New valve leakage rate different than previous valve.	See System Tuning Process and repeat the tuning steps.

Vektek LLC 1334 East Sixth Ave. P.O. Box 625 Emporia, Ks. 66801 U.S.A.	Instruction Sheet	IS5003			
		REV:	E	ECN:	5587
		REV. BY/DATE:	KR	01/27/25	
		APPR/DATE:	BCD	01/27/25	
TITLE: Pneumatic Confirmation Application Setup Guide					

Part Present Sensing Work Supports: High Capacity Work Supports Application Guide



Introduction:

The part present sensing contact bolt feature can be utilized for part position confirmation while loading or during the machining process. This adds an extra element of part position confirmation for part feedback fixture designs. This instruction guide will go over recommended circuit supplies needed and recommendations for how to set up a feedback circuit using the part present sensing work supports.

Part Present Sensing Circuit Design:

Vektek recommends the following components to create the pneumatic pressure circuit for use with the Part Present Sensing Work Supports. Refer to the circuit design below and position the components in the order shown starting at the air supply if using your own components. The maximum amount of devices in the circuit depends on several factors. However, pressure drop over the length of the circuit path is a function related to the maximum amount of devices you are able to use. The max operating pressure is 15 psi.

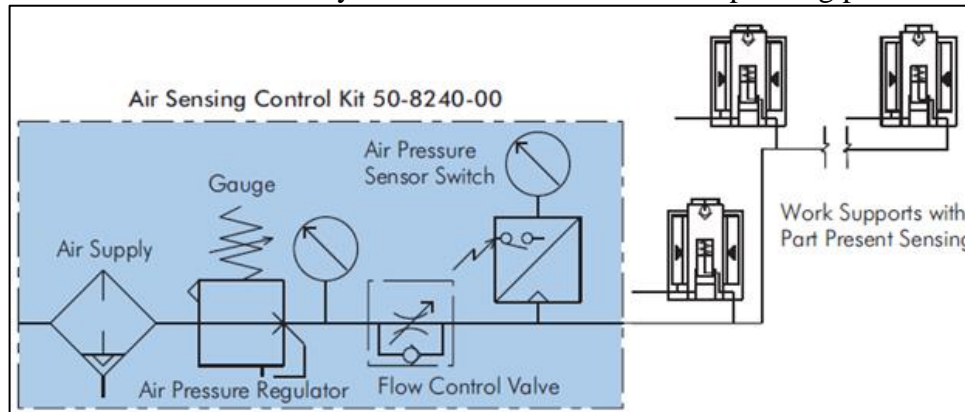

Vekttek LLC 1334 East Sixth Ave. P.O. Box 625 Emporia, Ks. 66801 U.S.A.	Instruction Sheet	IS5003			
		REV:	E	ECN:	5587
		REV. BY/DATE:	KR	01/27/25	
		APPR/DATE:	BCD	01/27/25	
TITLE: Pneumatic Confirmation Application Setup Guide					

Circuit Components:

1. Constant air supply.
2. Vekttek Air Sensing Control Kit.
3. Model No. 50-8240-00
4. Vekttek Part Present Sensing (PPS) Work Supports
5. Model No. 10-0706-10-PS, 10-0806-20-PS, 10-0706-16-PS, 10-0806-26-PS, 10-0708-10-PS, 10-0808-20-PS, 10-0708-16-PS, 10-0808-26-PS, 10-0710-10-PS, or 10-0810-20-PS
6. Refer to ILS100731 for cavity dimensions. See catalog work support section or contact Vekttek for more information.
7. Refer to ILS100722 for base mount dimensions.
Important!! Note Hydraulic vs Air manifold locations on base.
8. Reference PL5000, PL5005 and IS5003 for more pneumatic sensing information.

Position Sensor Setup:

The following steps provide instructions related to signal logic and system tuning.

System Tuning Information

Start your process by tuning the air supply so proper repeatable feedback confirmation can be achieved. (Before the system can be tuned, the following parameters must be defined.)

Valve "Closed" Pressure: _____ PSI
Sensor "Set Point" Pressure (SP1) _____ PSI
Sensor "Reset" Pressure (RP1) _____ PSI
Valve "Open" Pressure _____ PSI

The Valve "Closed" Pressure is the back pressure that builds when all the valves in the circuit are closed. This parameter needs to be higher than all other pressures. This pressure is tuned by adjusting the pressure regulator. Vekttek recommends 15 PSI (100 kPa).

The Sensor "Set Point" Pressure is the pressure chosen and programmed into the sensor switch that will cause a change of state during pressure rise. This pressure must be lower than the Valve "Closed" Pressure. Vekttek recommends about 60% of the valve closed pressure or 10 PSI (70 kPa).

Vekttek LLC 1334 East Sixth Ave. P.O. Box 625 Emporia, Ks. 66801 U.S.A.	Instruction Sheet	IS5003			
		REV:	E	ECN:	5587
		REV. BY/DATE:	KR	01/27/25	
		APPR/DATE:	BCD	01/27/25	
TITLE: Pneumatic Confirmation Application Setup Guide					

The Sensor “Reset” Pressure is the pressure chosen and programmed into the sensor switch that will cause a change of state during pressure fall. This pressure must be lower than the Sensor “Set Point” Pressure. Vekttek recommends about 40% of the valve closed pressure or 5 PSI (35 kPa).

The Valve “Open” Pressure is the low pressure level resulting from the valve at end of the circuit being open, all other valves closed. Vekttek recommends about 20% of the valve closed pressure or 3 PSI (20 kPa). This pressure is tuned by adjusting the flow control valve.

Vektek LLC 1334 East Sixth Ave. P.O. Box 625 Emporia, Ks. 66801 U.S.A.	Instruction Sheet	IS5003		
		REV: E	ECN: 5587	
		REV. BY/DATE: KR	01/27/25	
		APPR/DATE: BCD	01/27/25	
TITLE: Pneumatic Confirmation Application Setup Guide				

Pressure Regulator Flow Control Electronic Pressure Switch



PART PRESENT SENSING WORK SUPPORT AIR FLOW

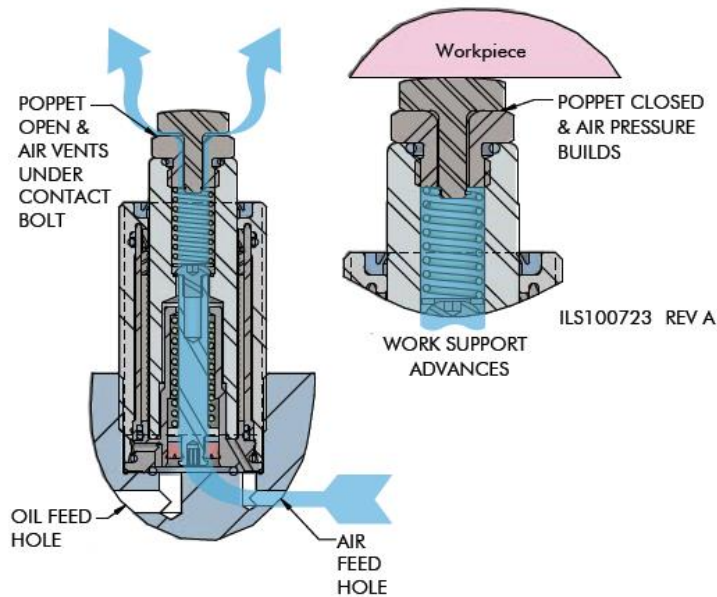

Vekttek LLC 1334 East Sixth Ave. P.O. Box 625 Emporia, Ks. 66801 U.S.A.	Instruction Sheet	IS5003		
		REV: E	ECN: 5587	
		REV. BY/DATE: KR	01/27/25	
		APPR/DATE: BCD	01/27/25	
TITLE: Pneumatic Confirmation Application Setup Guide				

System Tuning Steps

The final step is tuning the system using Air Sensing Control Kit and cycling clamps with the “part” in place. Refer to the figures above and below.

- 1) Cycle clamps so that all the valves are in the “Closed” position.
- 2) Adjust the air pressure regulator until the desired Valve “Closed” Pressure is achieved.
- 3) Determine the furthest away part position sensor from the pressure sensor switch.
- 4) Adjust the flow control valve so that Valve “Open” Pressure is achieved.
 - a. Helpful hint: Set a .25” spacer on top of the part position sensor contact bolt. Cycle the clamps to the “clamped” position. Remove the .25” spacer so the air can escape.
- 5) Repeat steps until both (open & closed) pressures are achieved. Adjusting the regulator or flow control can change both the “Closed” & “Open” pressures.

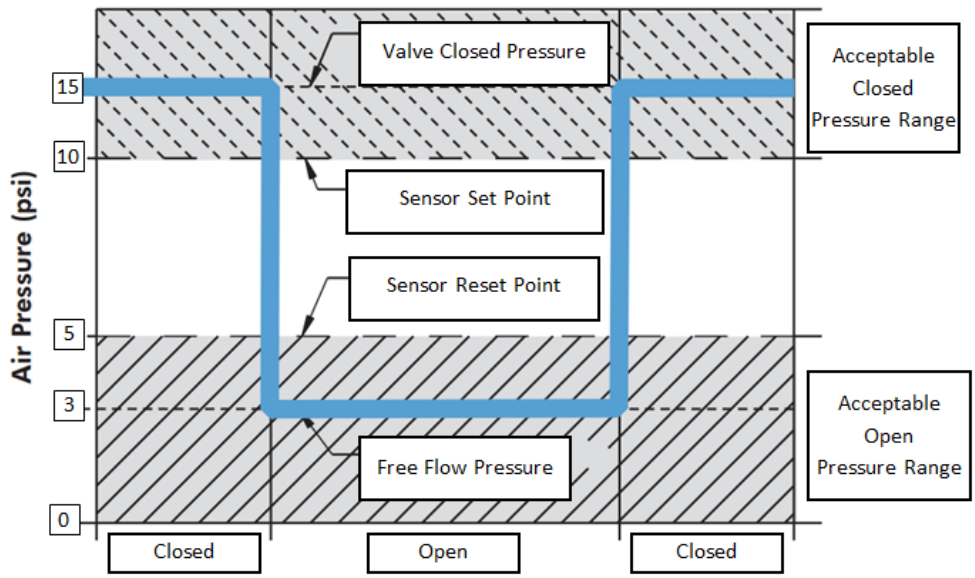

Vektek LLC 1334 East Sixth Ave. P.O. Box 625 Emporia, Ks. 66801 U.S.A.	Instruction Sheet	IS5003			
		REV:	E	ECN:	5587
		REV. BY/DATE:	KR	01/27/25	
		APPR/DATE:	BCD	01/27/25	
TITLE: Pneumatic Confirmation Application Setup Guide					

Trouble Shooting

Problem	Cause	Corrective Action
My system will not build pressure.	Valve(s) are not being closed.	Confirm all PPS Contact bolts are closed
My system will not drop pressure.	Pressure and flow are too high.	Decrease pressure and flow by adjusting pressure regulator and flow control. See System Tuning Process and repeat the tuning steps.